













MONTAGEANLEITUNG

-  MONTAGEANLEITUNG
-  ASSEMBLY INSTRUCTION
-  DE INSTRUCTIE VAN DE ASSEMBLAGE
-  ISTRUZIONE DELL'ASSEMBLEA
-  INSTRUCCIÓN DE ASAMBLEA
-  INSTRUCTION DE MONTAGE
-  NÁVOD K MONTÁŽI
-  MONTERINGSANVISNING

-  MONTAJ TALIMATI
-  ASENNUSOHJE
-  BRUGSANVISNING
-  BRUKSANVISNING
-  UPUTE ZA MONTAŽU
-  NAVODILA ZA MONTAŽO
-  SZERELÉSI ÚTMUTATÓ
-  INSTRUCTIUNI DE MONTAJ

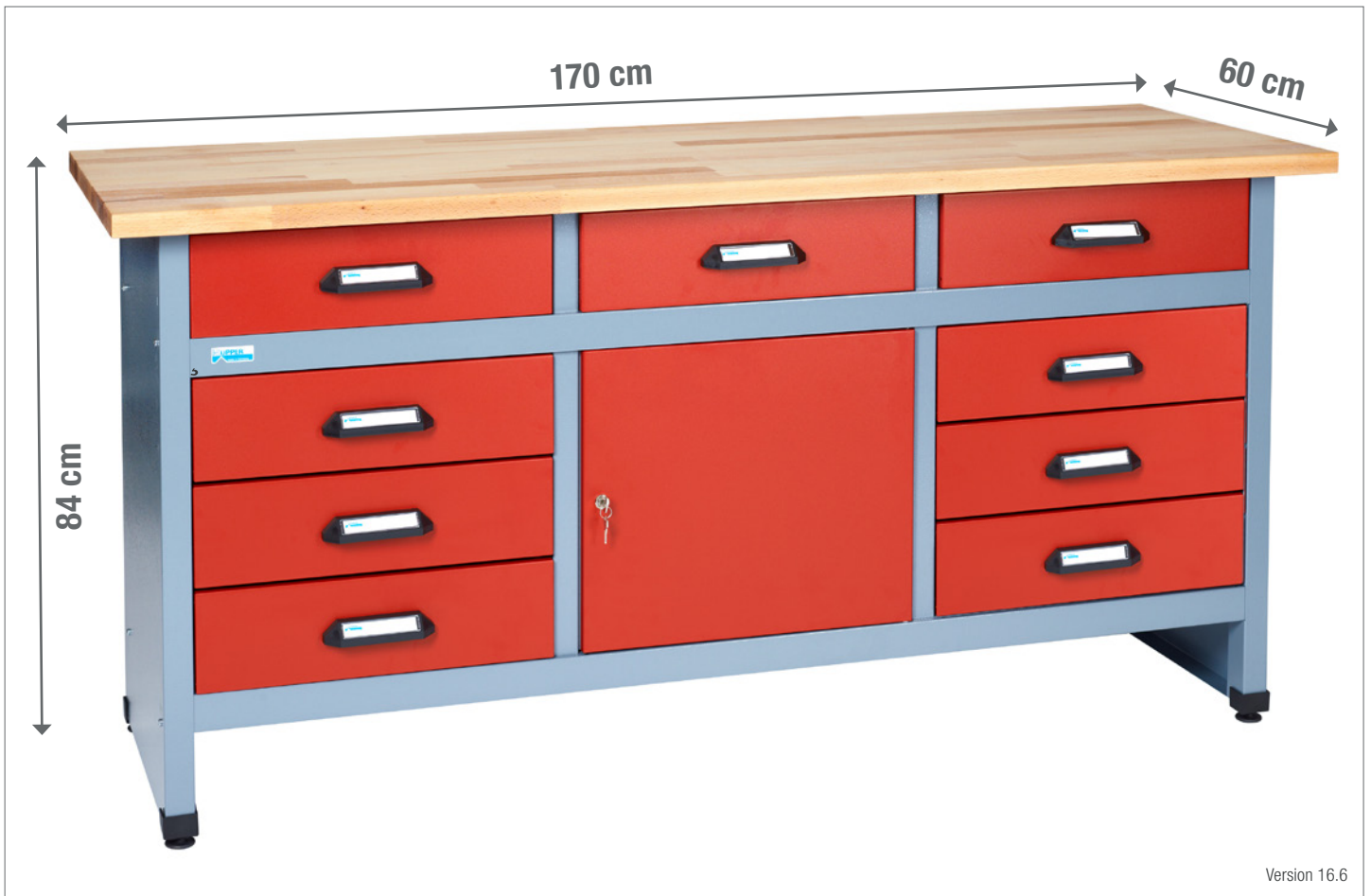

Modell-Nr.

12870

ART.-NR. FRONT KORPUS

12872  Rot (ähnl. RAL 3002)  Silber

12877  Ultramarinblau (RAL 5002)  Silber

12876  Silber  Schwarz (RAL 9005)

Friedrich Küpper GmbH
Friedrich-Küpper-Weg
54570 Berlingen
Deutschland

Telefon +49 (0) 65 91 - 95 42 0
Telefax +49 (0) 65 91 - 95 42 17
E-Mail info@friedrich-kuepper-gmbh.de
Internet www.friedrich-kuepper-gmbh.de

EINZELTEILE / PIECES

1× **A**

772 mm × 475 mm

Art.-Nr. E0154 (Silber/silver)
Art.-Nr. E0155 (Schwarz/black)



1× **C**

1570 mm × 473 mm

Art.-Nr. E0179 (Silber/silver)
Art.-Nr. E0180 (Schwarz/black)



1× **B**

772 mm × 475 mm

Art.-Nr. E0165 (Silber/silver)
Art.-Nr. E0166 (Schwarz/black)



1× **D**

1570 mm × 473 mm

Art.-Nr. E0191 (Silber/silver)
Art.-Nr. E0192 (Schwarz/black)



2× **F**

645 mm × 450 mm

Art.-Nr. E0211 (Silber/silver)
Art.-Nr. E0212 (Schwarz/black)



1× **E**

1500 mm × 480 mm

Art.-Nr. E0200 (Silber/silver)

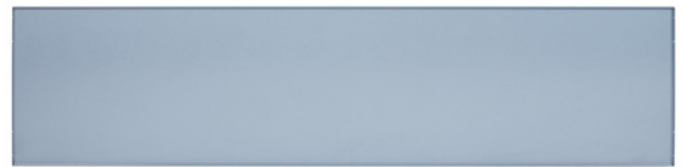

1× **K**

403 mm × 468 mm

Art.-Nr. E0230 (Silber/silver)
Art.-Nr. E0227 (Rot/red)
Art.-Nr. E0229 (Blau/blue)



1× **Y**

1700 mm × 600 mm

Art.-Nr. E0257



1× **L**

400 mm × 25 mm

Art.-Nr. E0233 (Silber/silver)
Art.-Nr. E0234 (Schwarz/black)



9× **J**

450 mm × 120 mm

Art.-Nr. E0224 (Silber/silver)



9× **H**

450 mm × 445 mm

Art.-Nr. E0215 (Silber/silver)



9× **I**

470 mm × 130 mm

Art.-Nr. E0221 (Silber/silver)
Art.-Nr. E0218 (Rot/red)
Art.-Nr. E0220 (Blau/blue)



9× **X**

450 mm × 20 mm

Art.-Nr. E0252 (Schwarz/black)



BEUTELINHALT / BAG CONTENT

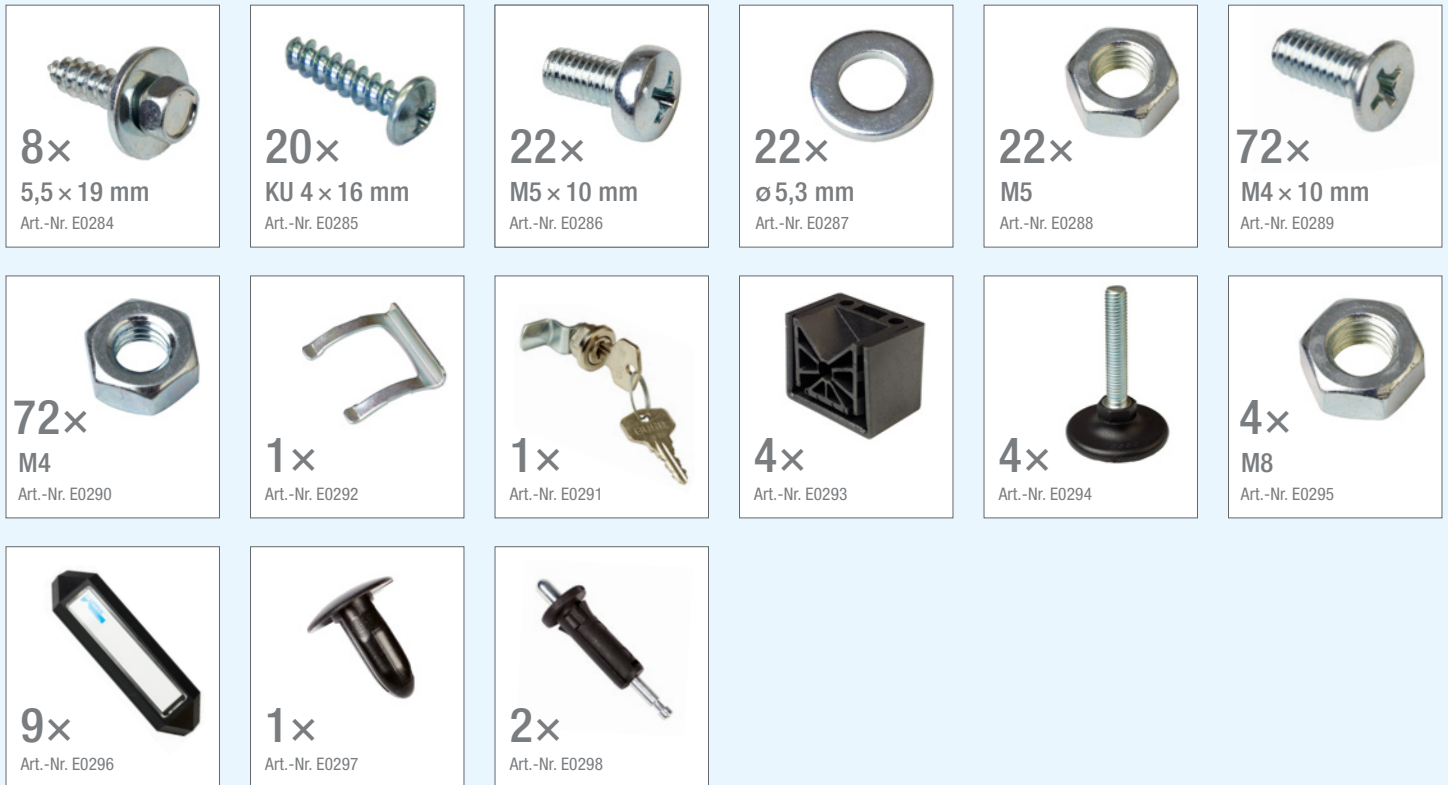

BENÖTIGTES WERKZEUG / NEEDED TOOLS

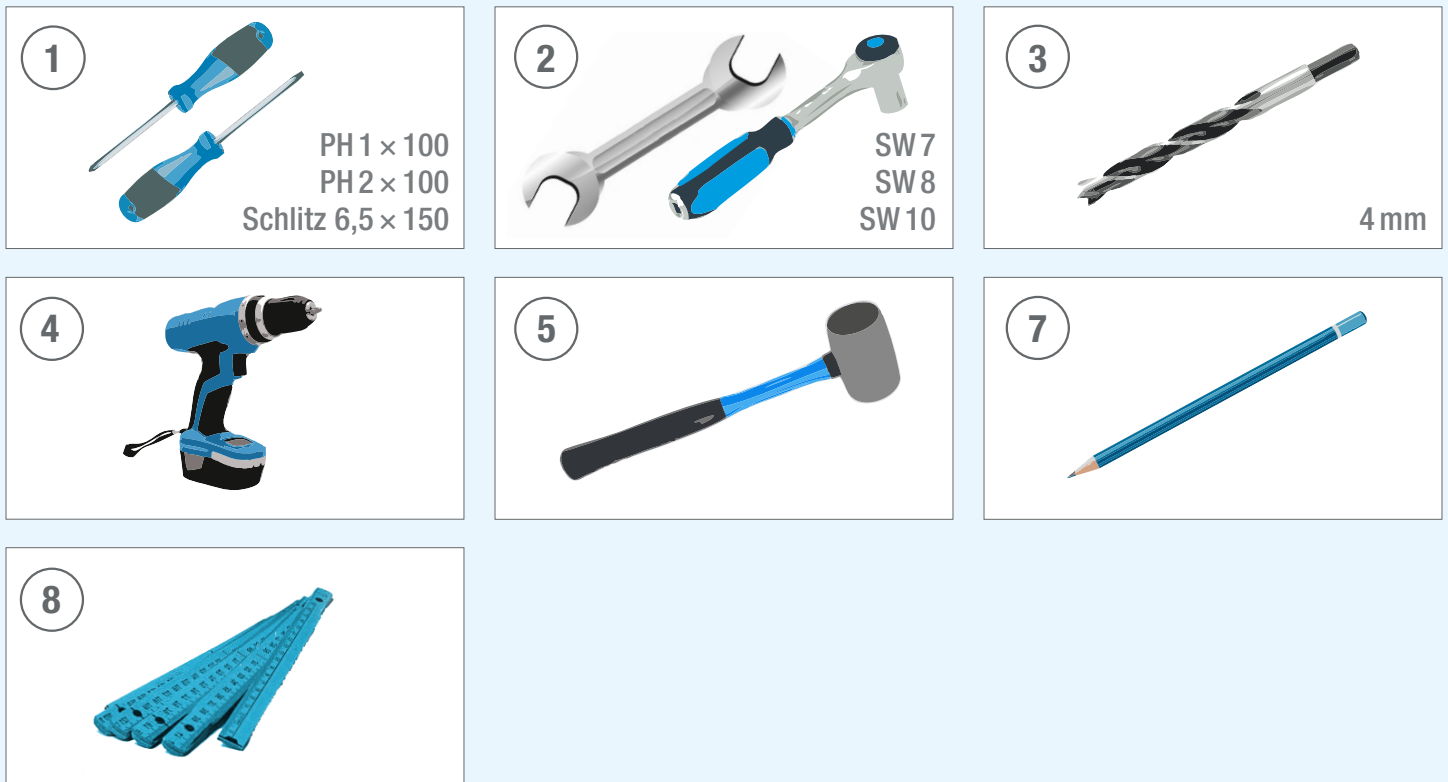

1. WICHTIG / IMPORTANT



2.

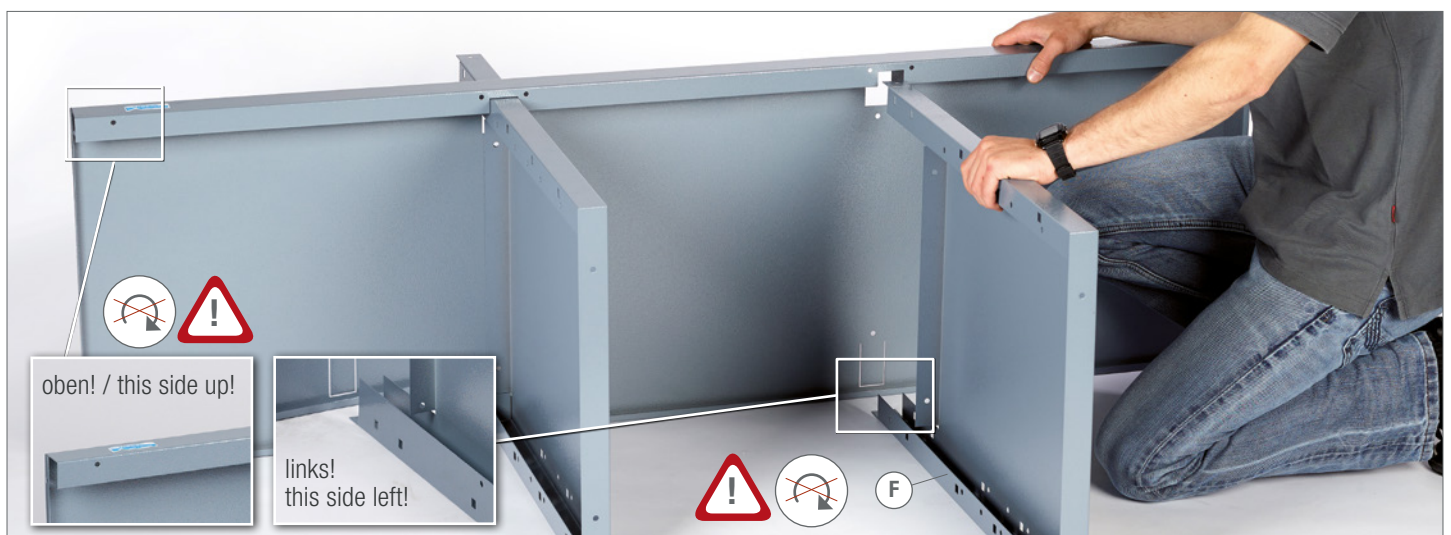

3.  4x M5  4x M5x10  4x 5,3MM

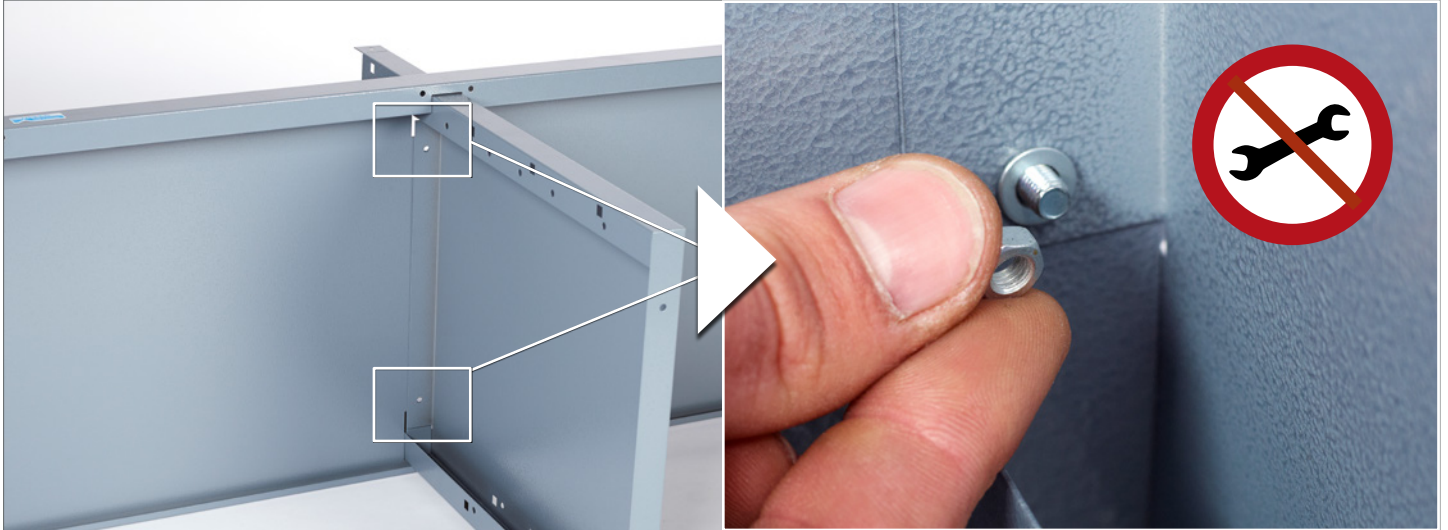

4.



5.  4x M5  4x M5x10  4x 5,3MM  ② SW8  ① PH2x100



6.



7.

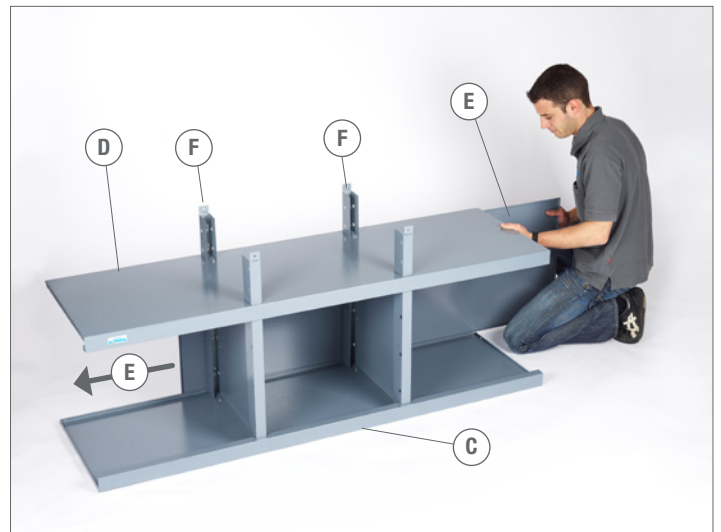

ZU SCHRITT 3. / IN ADDITION TO STEP 3.

②  SW 8 ①  PH 2 × 100

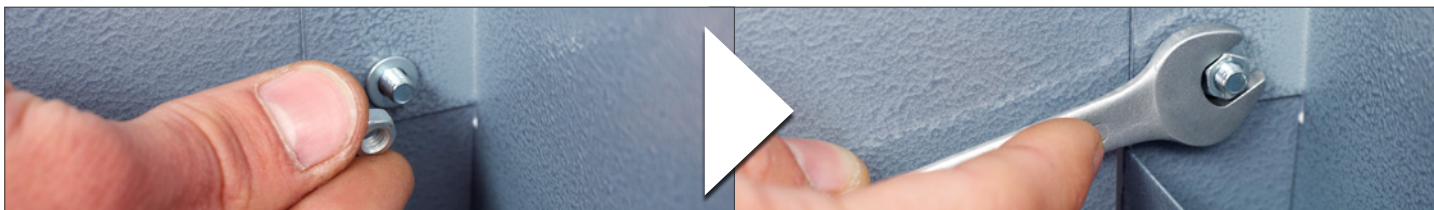

8. WICHTIG / IMPORTANT



9.  6 × M5  6 × M5 × 10  6 × 5,3 MM ②  SW 8 ①  PH 2 × 100



10.  6 × M5  6 × M5 × 10  6 × 5,3 MM ②  SW 8 ①  PH 2 × 100



11.

4x M8 4x 4x 4x

5



12.

2x KU4x16 1x

1 PH2x100

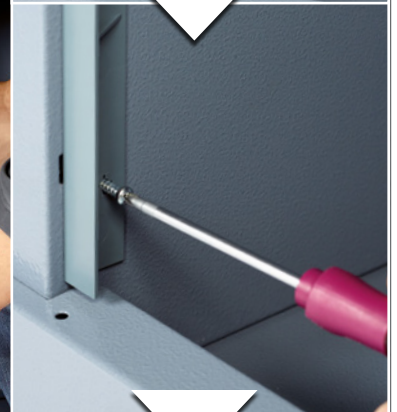

13.



14.

⑧ ⑦



15.

④ ③



16.

8x5,5x19

② SW 8



17. 2x



18.



19.



20.

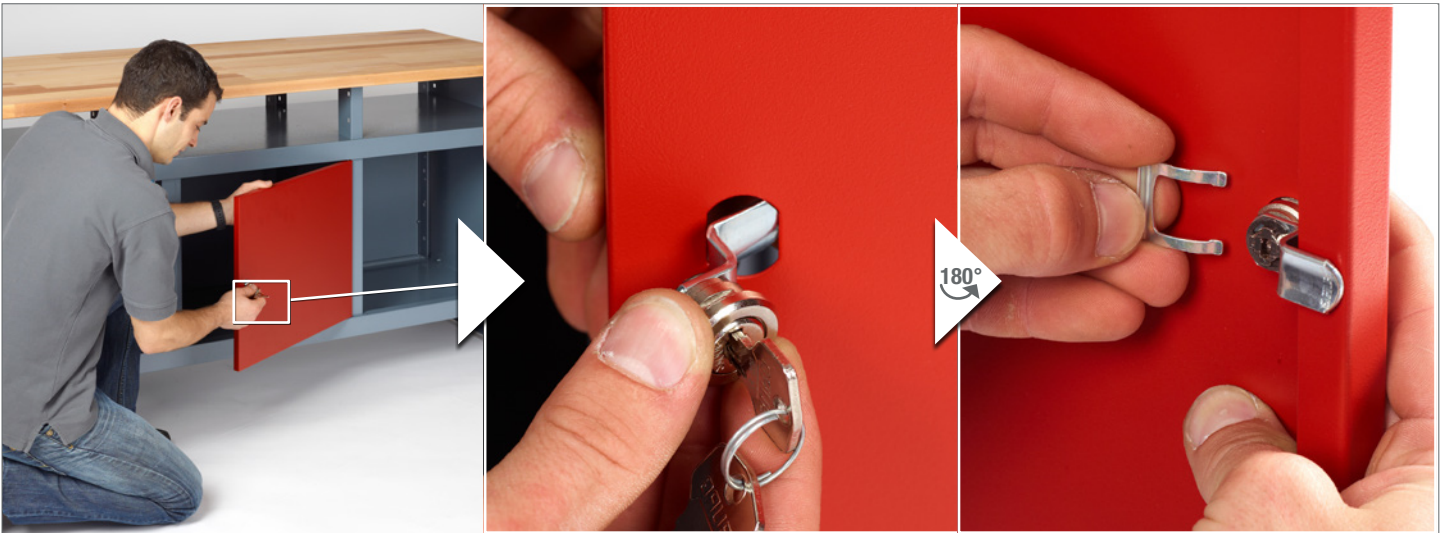

21.



22.



23. 18x M4 18x M4 x 10

② SW7 ① PH1 x 100

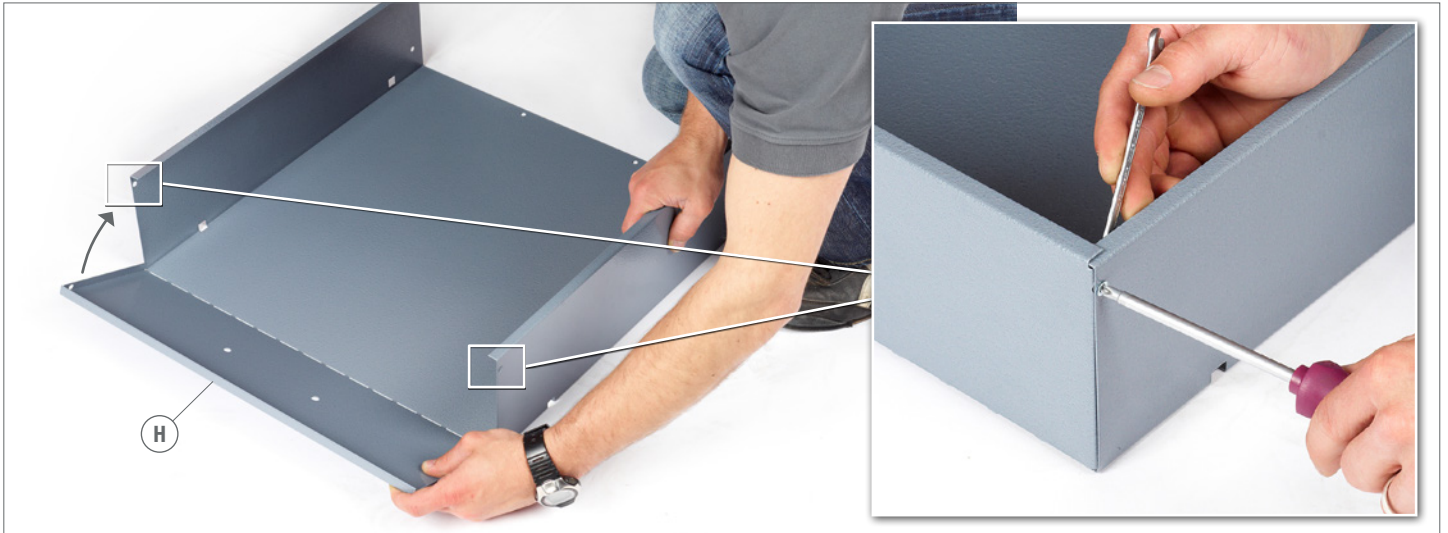

24. 54x M4 54x M4 x 10

② SW7 ① PH1 x 100

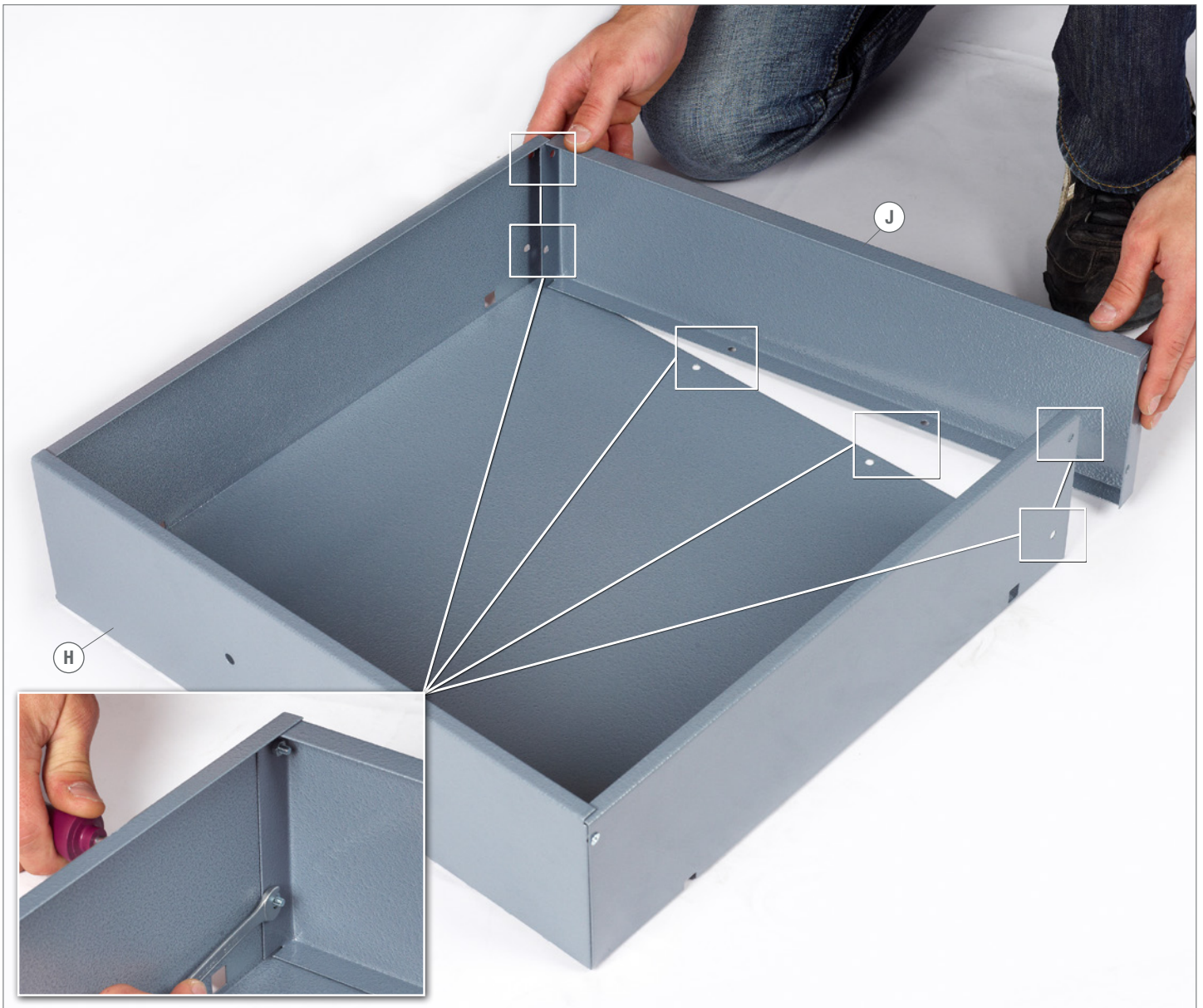

25.

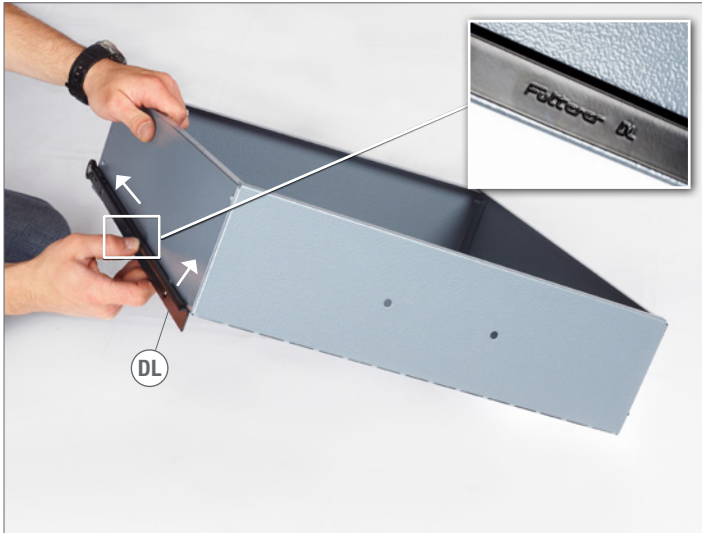

26.

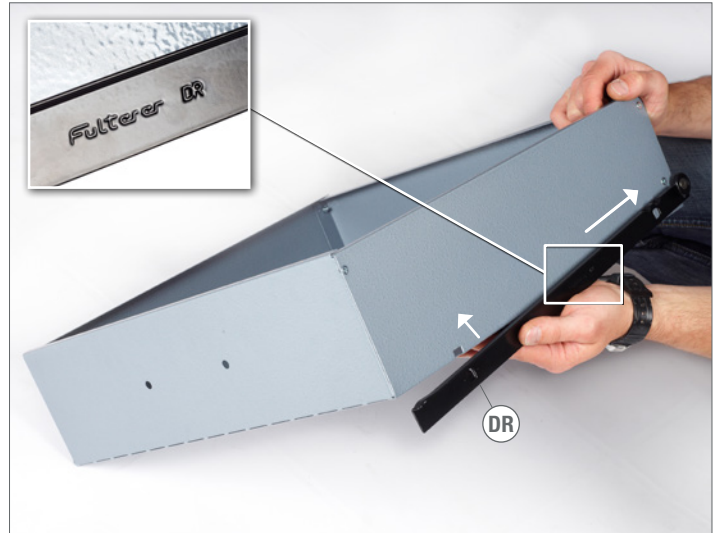

27.



28.

18x KU 4 x 16 9x  ①  PH 2 x 100



29.



30.





Modell-Nr.

12870