

















MONTAGEANLEITUNG

-  MONTAGEANLEITUNG
-  ASSEMBLY INSTRUCTION
-  DE INSTRUCTIE VAN DE ASSEMBLAGE
-  ISTRUZIONI DI MONTAGGIO
-  INSTRUCCIÓN DE ASAMBLEA
-  INSTRUCTION DE MONTAGE
-  NÁVOD K MONTÁŽI
-  MONTERINGSANVISNING

-  MONTAJ TALIMATI
-  ASENNUSOHJE
-  BRUGSANVISNING
-  BRUKSANVISNING
-  UPUTE ZA MONTAŽU
-  NAVODILA ZA MONTAŽO
-  SZERELÉSI ÚTMUTATÓ
-  INSTRUCTIUNI DE MONTAJ



Modell-Nr.

12150

ART.-NR. FRONT KORPUS

12152

Rot
(ähnl. RAL 3002)

Silber

12157

Ultramarinblau
(RAL 5002)

Silber

12156

Silber

Schwarz
(RAL 9005)

Friedrich Küpper GmbH
Friedrich-Küpper-Weg
54570 Berlingen
Deutschland

Telefon +49 (0) 65 91 - 95 42 0
Telefa x +49 (0) 65 91 - 95 42 17
E-Mail info@friedrich-kuepper.de
Internet www.friedrich-kuepper.de

EINZELTEILE / PIECES

1× **A**

772 mm × 475 mm

Art.-Nr. E0154 (Silber/silver)
Art.-Nr. E0155 (Schwarz/black)



1× **C**

1570 mm × 473 mm

Art.-Nr. E0179 (Silber/silver)
Art.-Nr. E0180 (Schwarz/black)



1× **B**

772 mm × 475 mm

Art.-Nr. E0165 (Silber/silver)
Art.-Nr. E0166 (Schwarz/black)



1× **D**

1570 mm × 473 mm

Art.-Nr. E0191 (Silber/silver)
Art.-Nr. E0192 (Schwarz/black)



2× **F**

645 mm × 450 mm

Art.-Nr. E0211 (Silber/silver)
Art.-Nr. E0212 (Schwarz/black)



1× **E**

1500 mm × 480 mm

Art.-Nr. E0200 (Silber/silver)

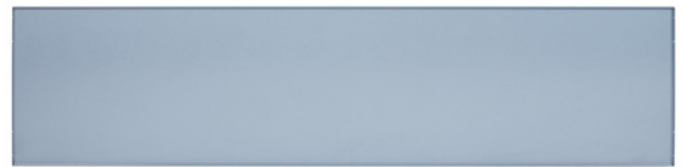

3× **K**

403 mm × 468 mm

Art.-Nr. E0230 (Silber/silver)
Art.-Nr. E0227 (Rot/red)
Art.-Nr. E0229 (Blau/blue)



1× **Y**

1700 mm × 600 mm

Art.-Nr. E0257



3× **L**

400 mm × 25 mm

Art.-Nr. E0233 (Silber/silver)
Art.-Nr. E0234 (Schwarz/black)



3× **J**

450 mm × 120 mm

Art.-Nr. E0224 (Silber/silver)



3× **H**

450 mm × 445 mm

Art.-Nr. E0215 (Silber/silver)



3× **I**

470 mm × 130 mm

Art.-Nr. E0221 (Silber/silver)
Art.-Nr. E0218 (Rot/red)
Art.-Nr. E0220 (Blau/blue)



3× **X**

450 mm × 20 mm

Art.-Nr. E0252 (Schwarz/black)



BEUTELINHALT / BAG CONTENT

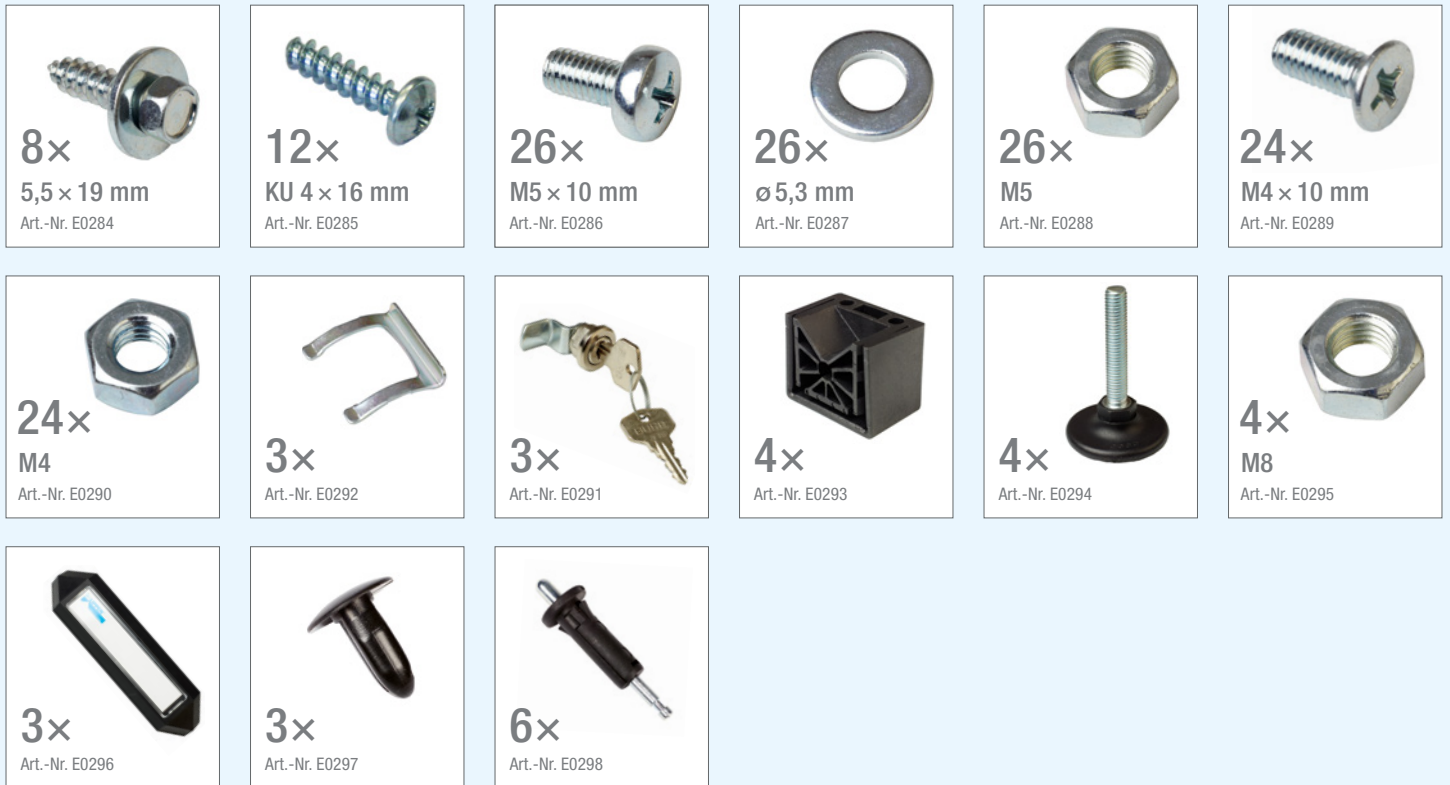

BENÖTIGTES WERKZEUG / NEEDED TOOLS

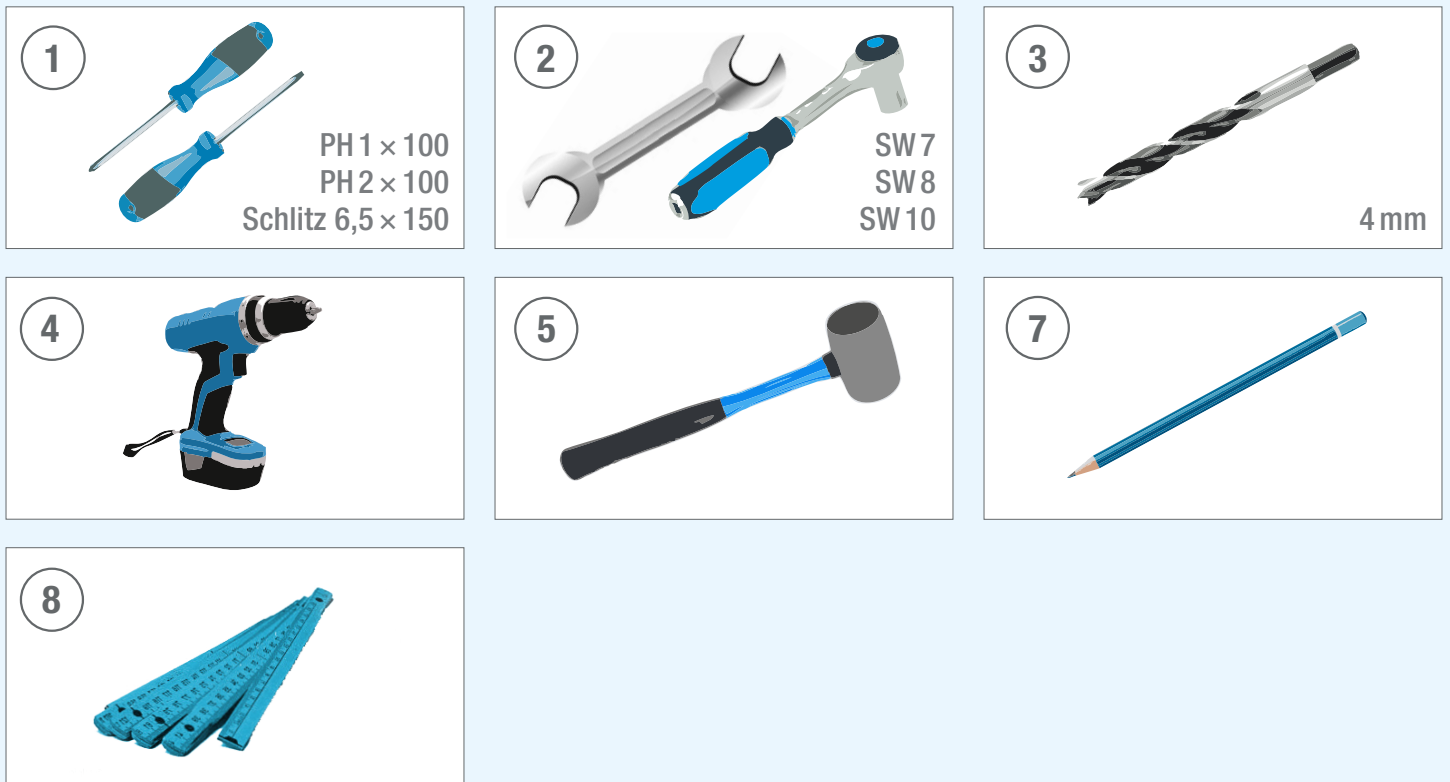

1. WICHTIG / IMPORTANT



2.

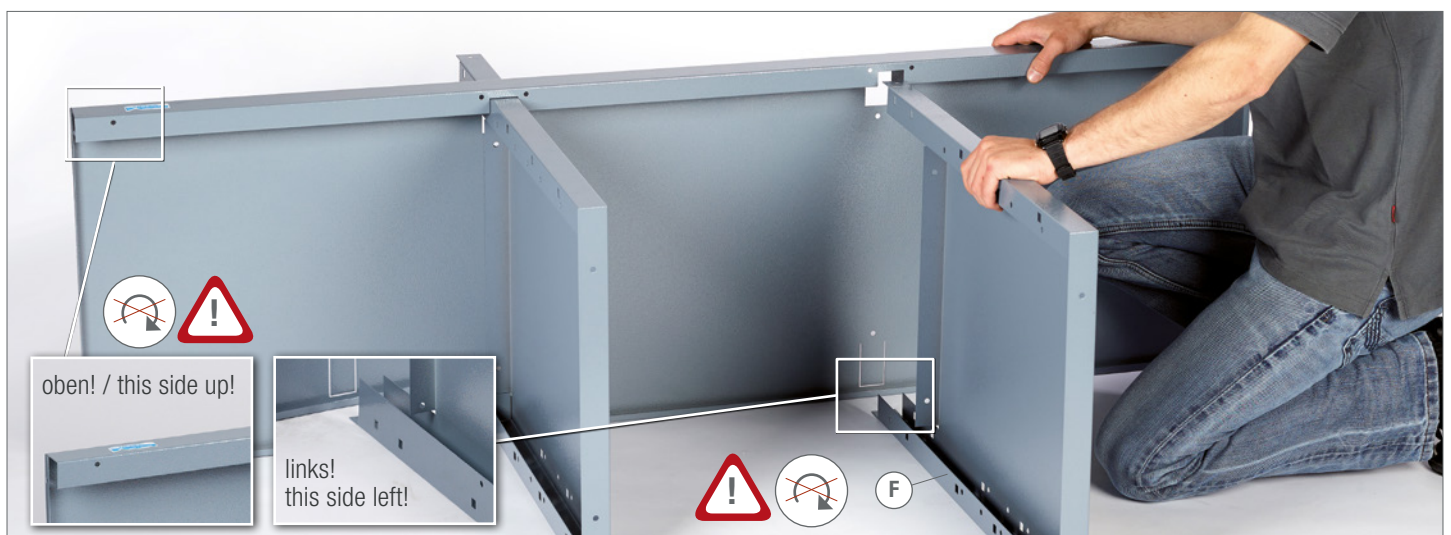

3.  4 × M5  4 × M5 × 10  4 × 5,3 MM

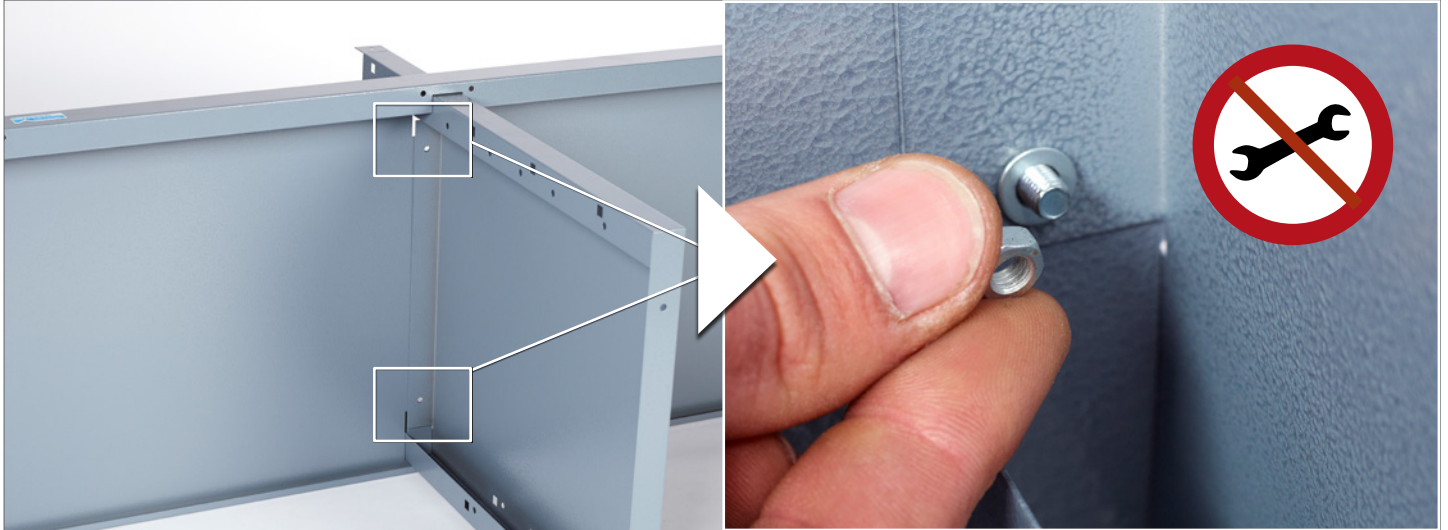

4.



5.  4 × M5  4 × M5 × 10  4 × 5,3 MM  ② SW 8  ① PH 2 × 100



6.



7.

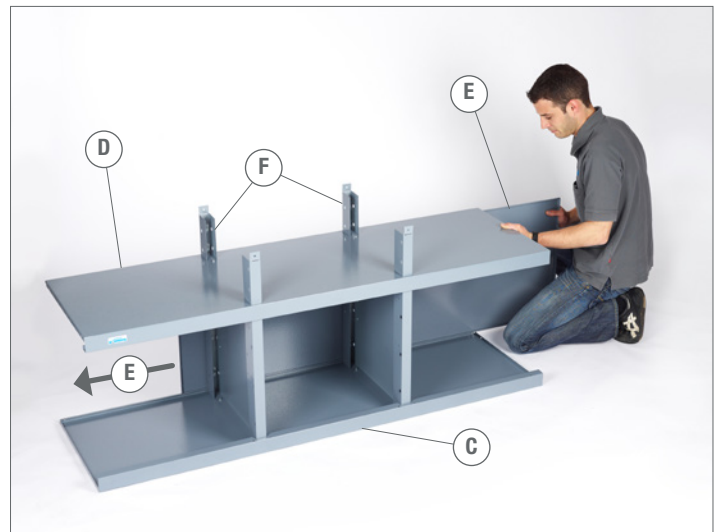

ZU SCHRITT 3. / IN ADDITION TO STEP 3.

②  SW 8 ①  PH2×100

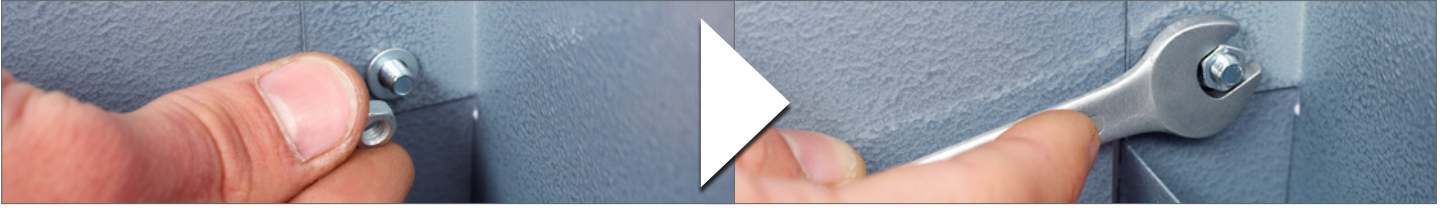

8. WICHTIG / IMPORTANT



9.  6×M5  6×M5×10  6×5,3MM ②  SW 8 ①  PH2×100



10.  6×M5  6×M5×10  6×5,3MM ②  SW 8 ①  PH2×100



11. 4x M8 4x 4x 4x

5



12. 6x KU 4 x 16 3x

1 PH 2 x 100

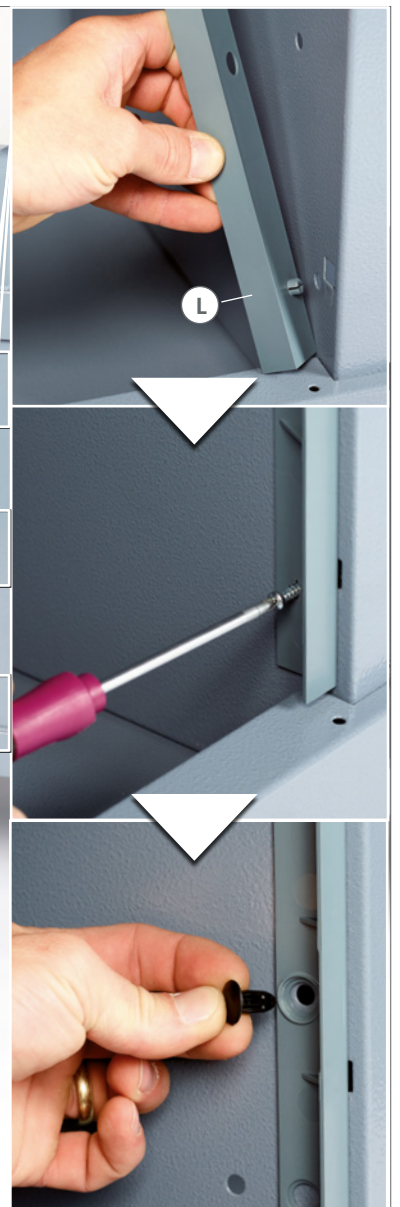

13.



14.

8 7

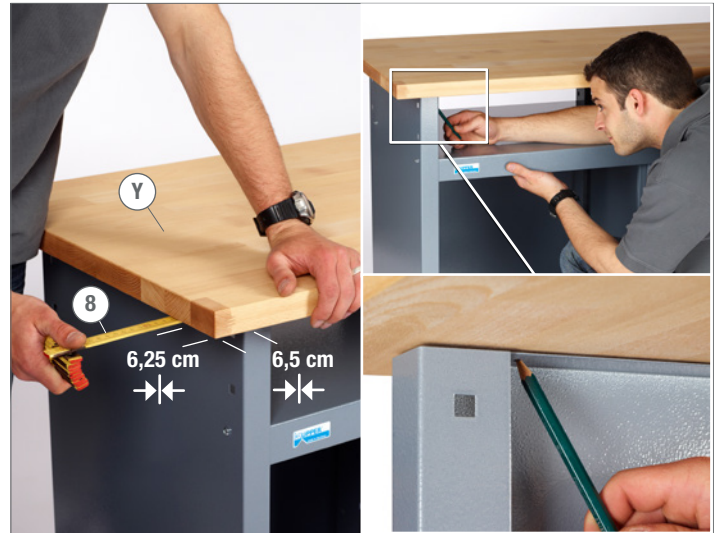

15.

4 3



16.

8x5,5x19

2 SW 8



17. 6x



18.



19.



20. 3x  3x 

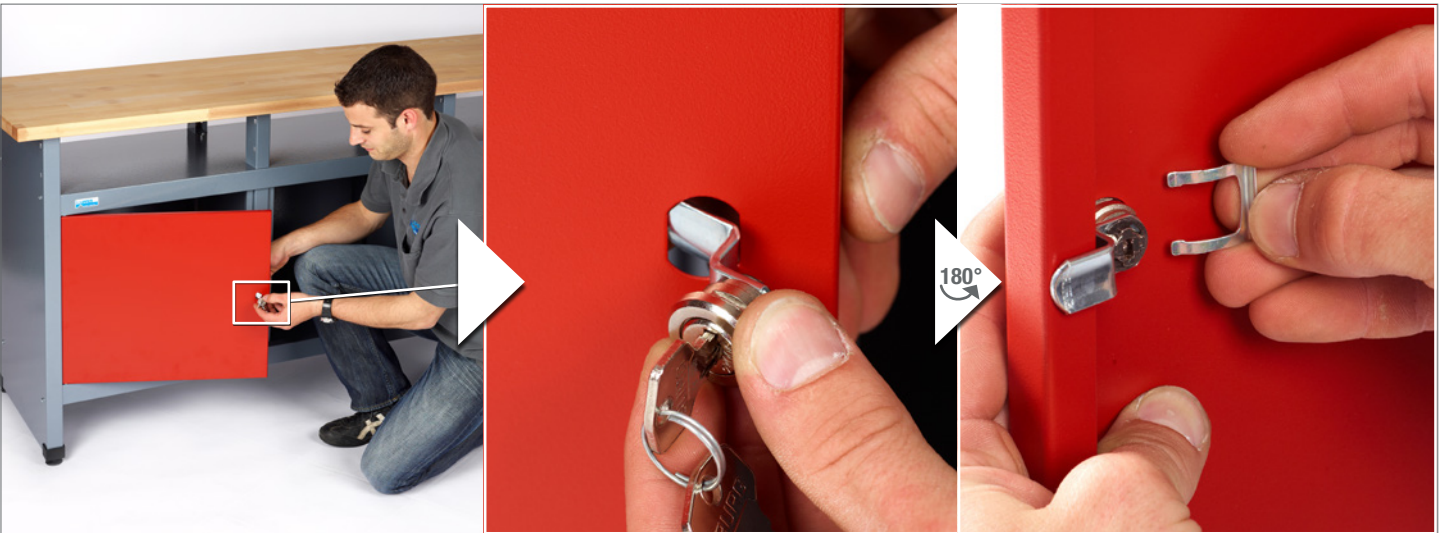

21.  3x CR



22.  3x CL



23.  6×M4  6×M4×10

 ② SW7  ① PH1×100

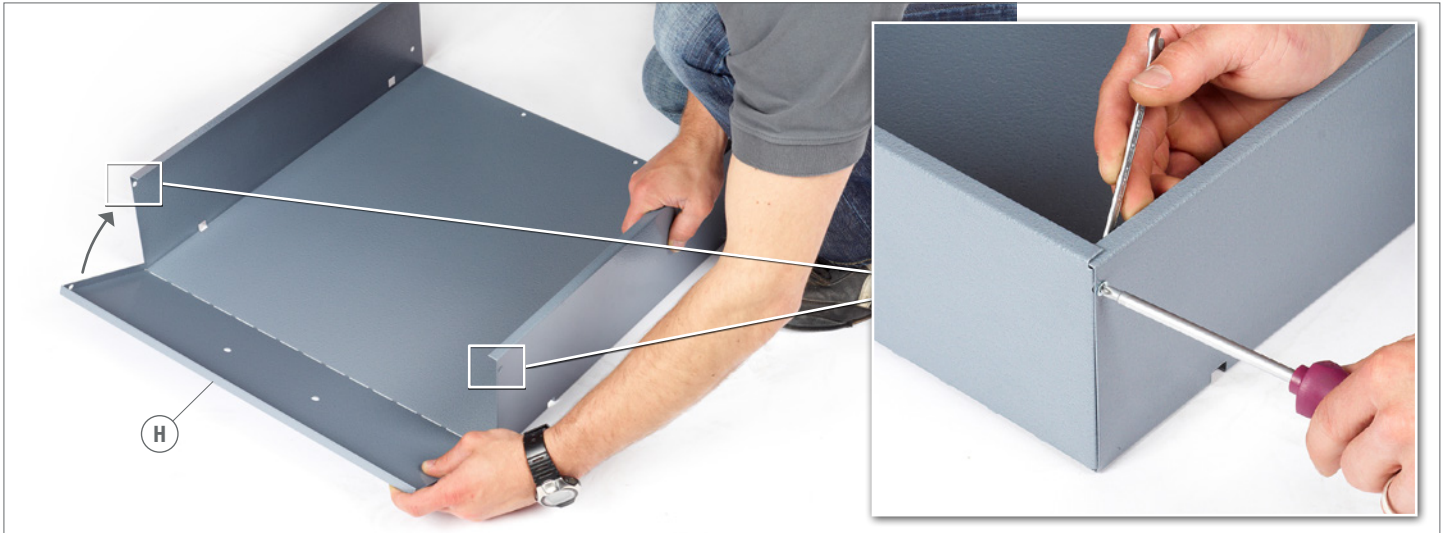

24.  18×M4  18×M4×10

 ② SW7  ① PH1×100

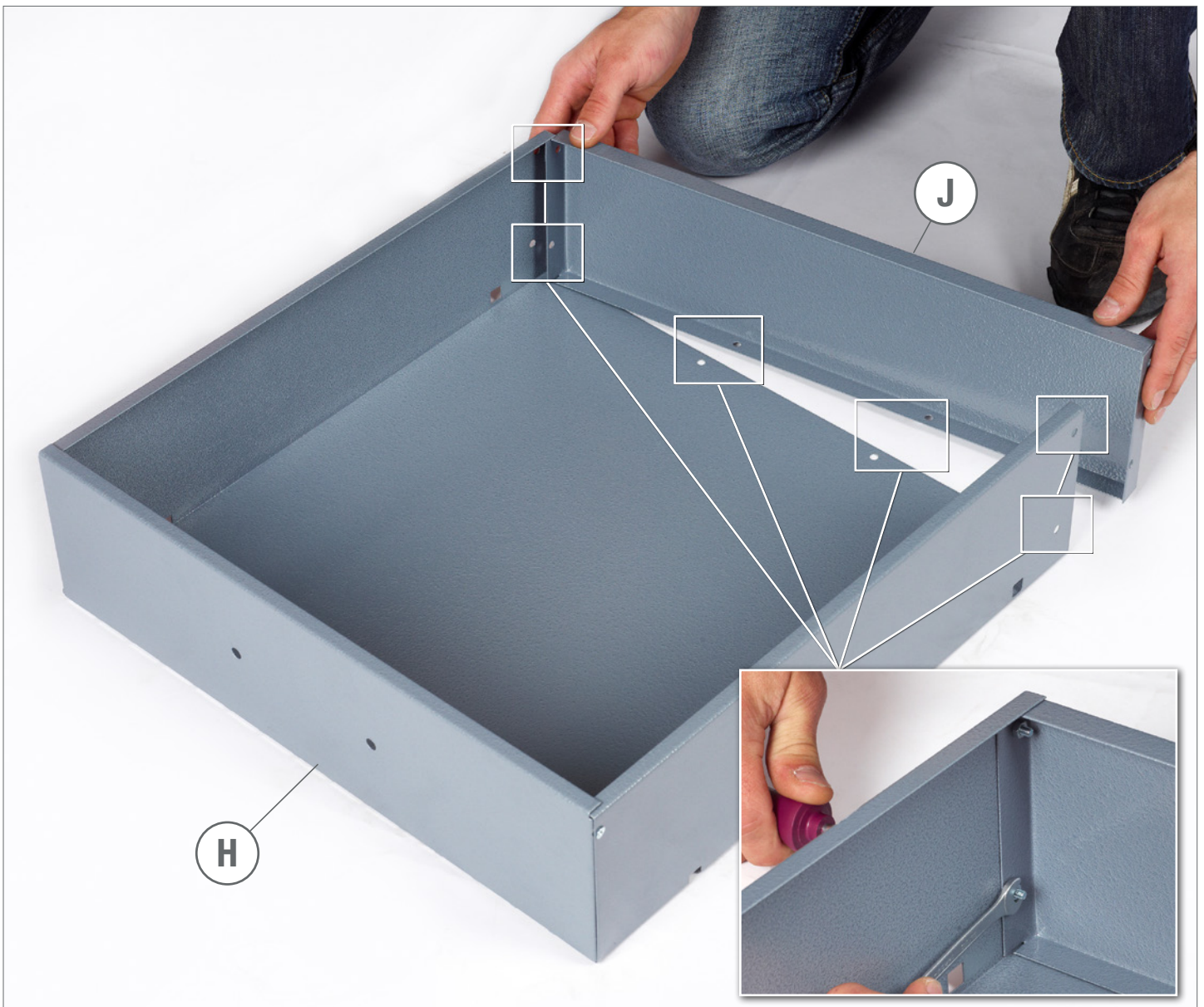

25.

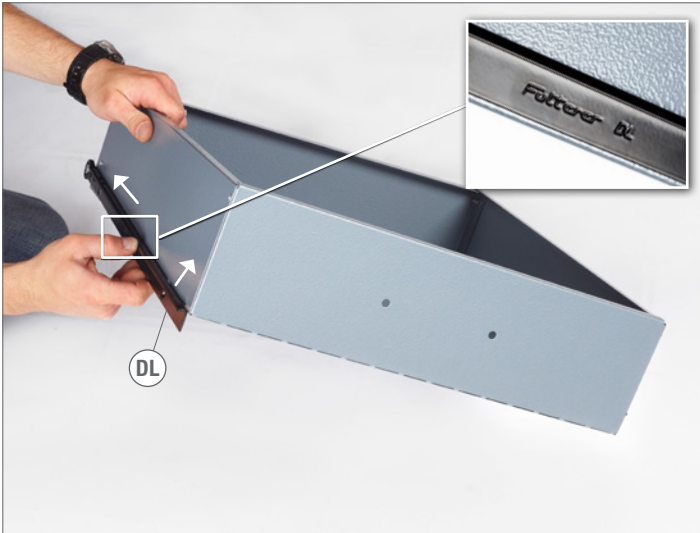

26.

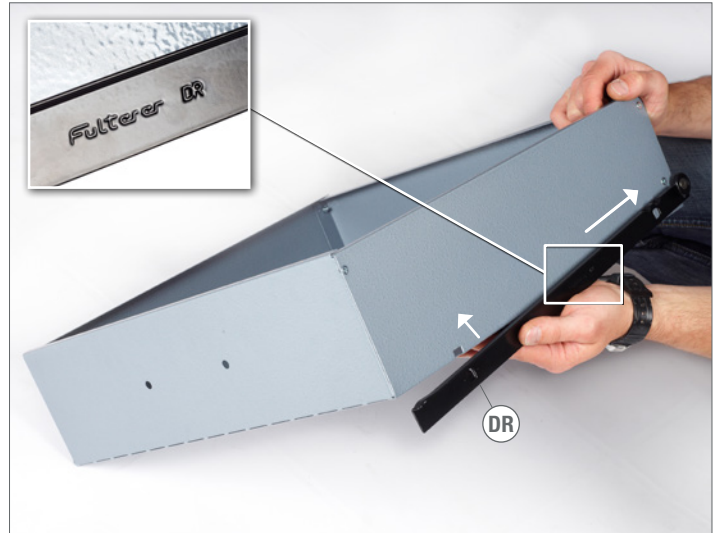

27.



28.

6 x KU 4 x 16



3 x

1 PH2 x 100



29.



30.

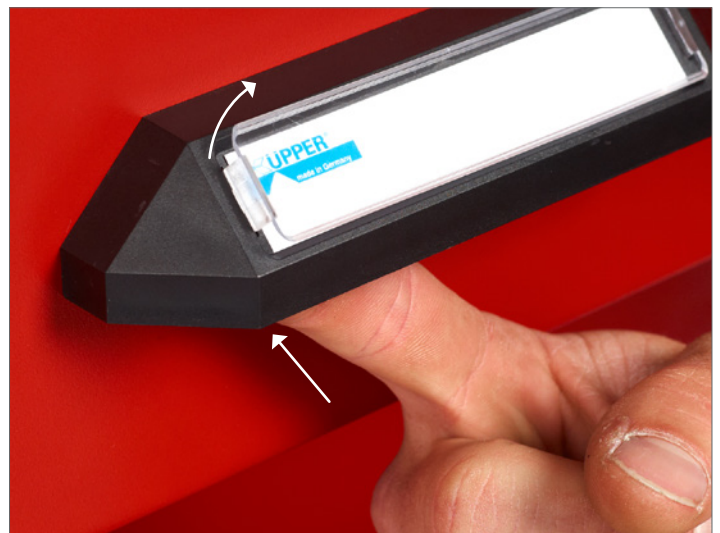



2019-07

Modell-Nr.

12150